

# SHERWIN WILLIAMS PRELIMINARY DEVELOPMENT PLAN PROJECT GRAPHICS



SUBMITTED BY

OWNER: SHERWIN WILLIAMS ACCEPTANCE CORPORATION (SWACE)  
PROJECT SPONSOR: LMC EMERYVILLE I INVESTOR LLC

PREPARED BY: LPAS AND CBG

SEPTEMBER 13, 2016



# SHERWIN WILLIAMS PRELIMINARY DEVELOPMENT PLAN

## PROJECT GRAPHICS TABLE OF CONTENTS

### CONTEXT

SURROUNDING LAND USE.....	1
VICINITY MAP.....	2
NEIGHBORHOOD TRANSPORTATION MAP.....	3
SITE AERIAL PHOTO.....	4
EXISTING CONDITIONS PLAN.....	5

### DEVELOPMENT GRAPHICS

LAND USE DIAGRAM.....	6
SITE DEVELOPMENT PLAN.....	7
ILLUSTRATIVE DEVELOPMENT GRAPHIC.....	8
GROUND FLOOR ACTIVATION.....	9
PUBLIC OPEN SPACE.....	10
OPEN SPACE PRECEDENTS.....	11
SITE TRANSPORTATION PLAN.....	12
VEHICULAR CIRCULATION.....	13
BICYCLE CIRCULATION.....	14
PEDESTRIAN CIRCULATION.....	15
FIRE ACCESS PLAN.....	16
LIGHTING PLAN.....	17
LANDSCAPE PLAN.....	18
LANDSCAPE PRECEDENTS.....	19
STORMWATER TREATMENT CONCEPT.....	20
STORMWATER TREATMENT DETAILS.....	21

GREENWAY MULTI-USE TRAIL SECTION.....	22
CONCEPTUAL GRADING PLAN.....	23
CONCEPTUAL UTILITY PLAN.....	24
SITE SECTION A.....	25
SITE SECTION B.....	26
SITE SECTION C.....	27
SITE SECTION D.....	28
SITE SECTION E.....	29
SITE SECTION F.....	30

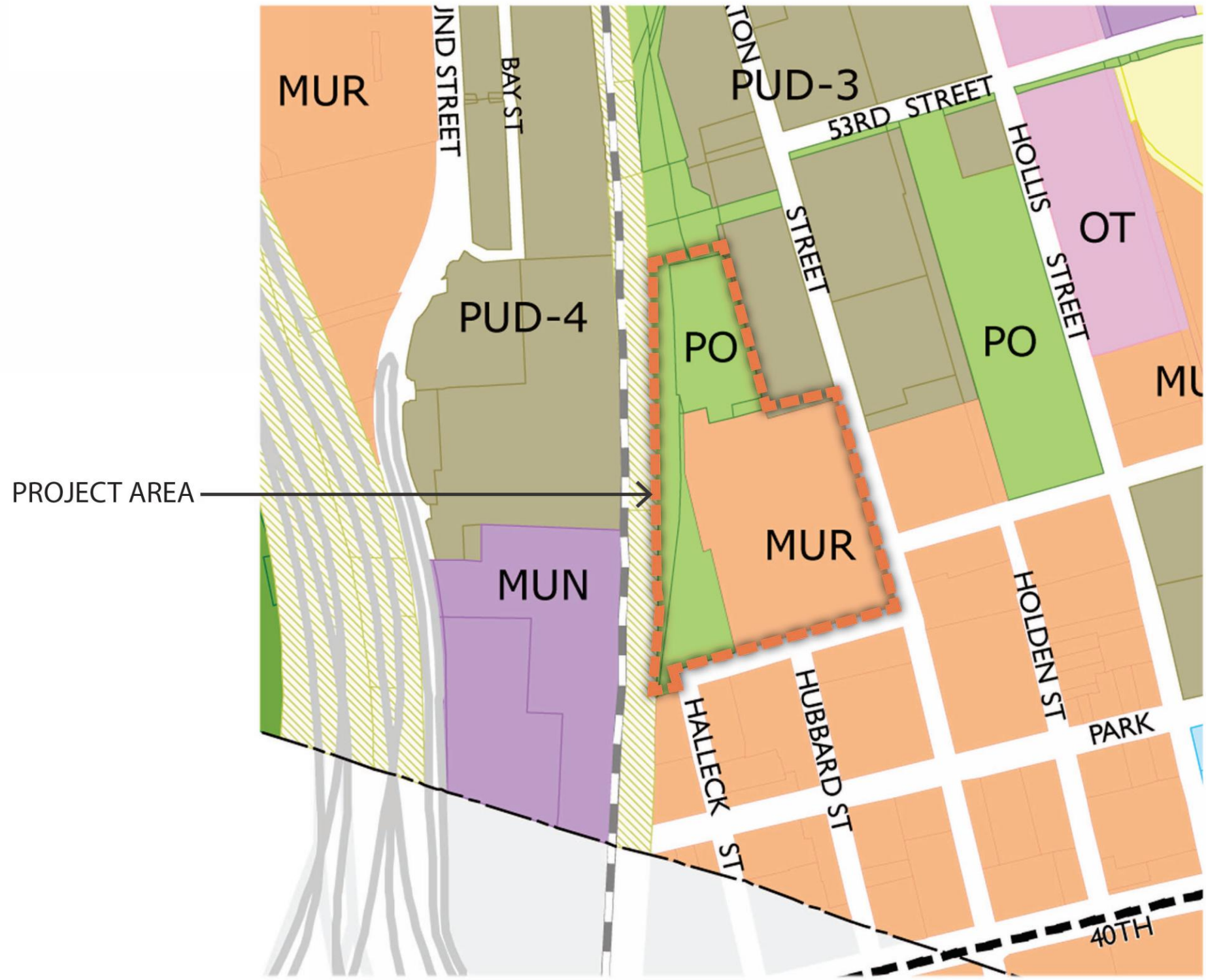

**LEGEND**

- RH High Density Residential
- RMH Medium-High Density Residential
- RM Medium Density Residential
- MUR Mixed Use with Residential
- MURS Mixed Use with Residential South
- MUN Mixed Use with Non-Residential
- OT Office/Technology
- OT/DH Office/Technology Doyle Hollis North Area
- INH Heavy Industrial
- INL Light Industrial
- P Public
- M Marina
- PO Park/Open Space
- SM Shoreline Management
- PUD Planned Unit Development
- UT Utilities/Transportation
- Railroad

NOT TO SCALE

**SURROUNDING LAND USE**





VICINITY MAP

NOT TO SCALE 





NEIGHBORHOOD TRANSPORTATION MAP

NOT TO SCALE 



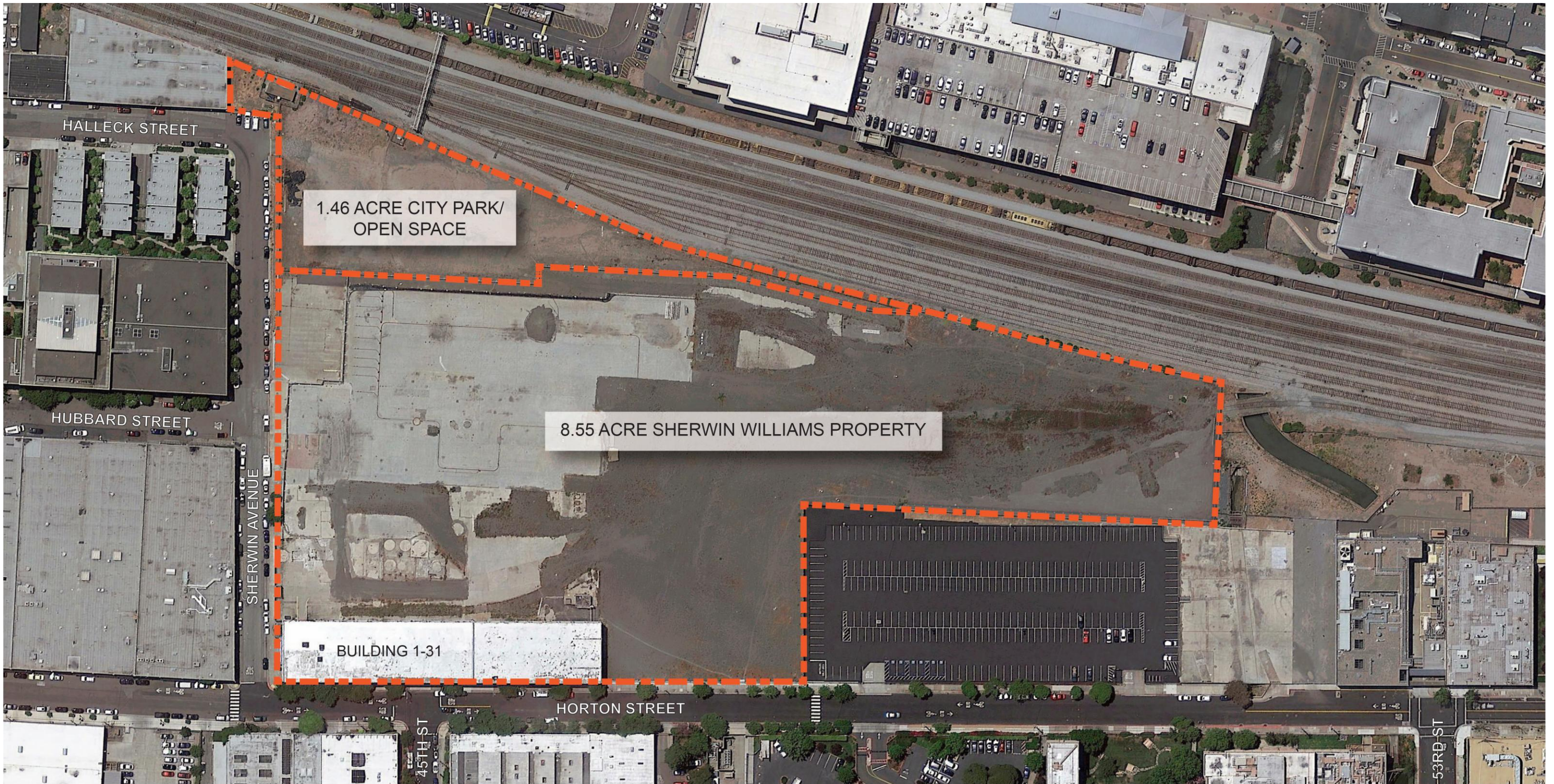

1.46 ACRE CITY PARK/  
OPEN SPACE

8.55 ACRE SHERWIN WILLIAMS PROPERTY

BUILDING 1-31

SITE AERIAL PHOTO



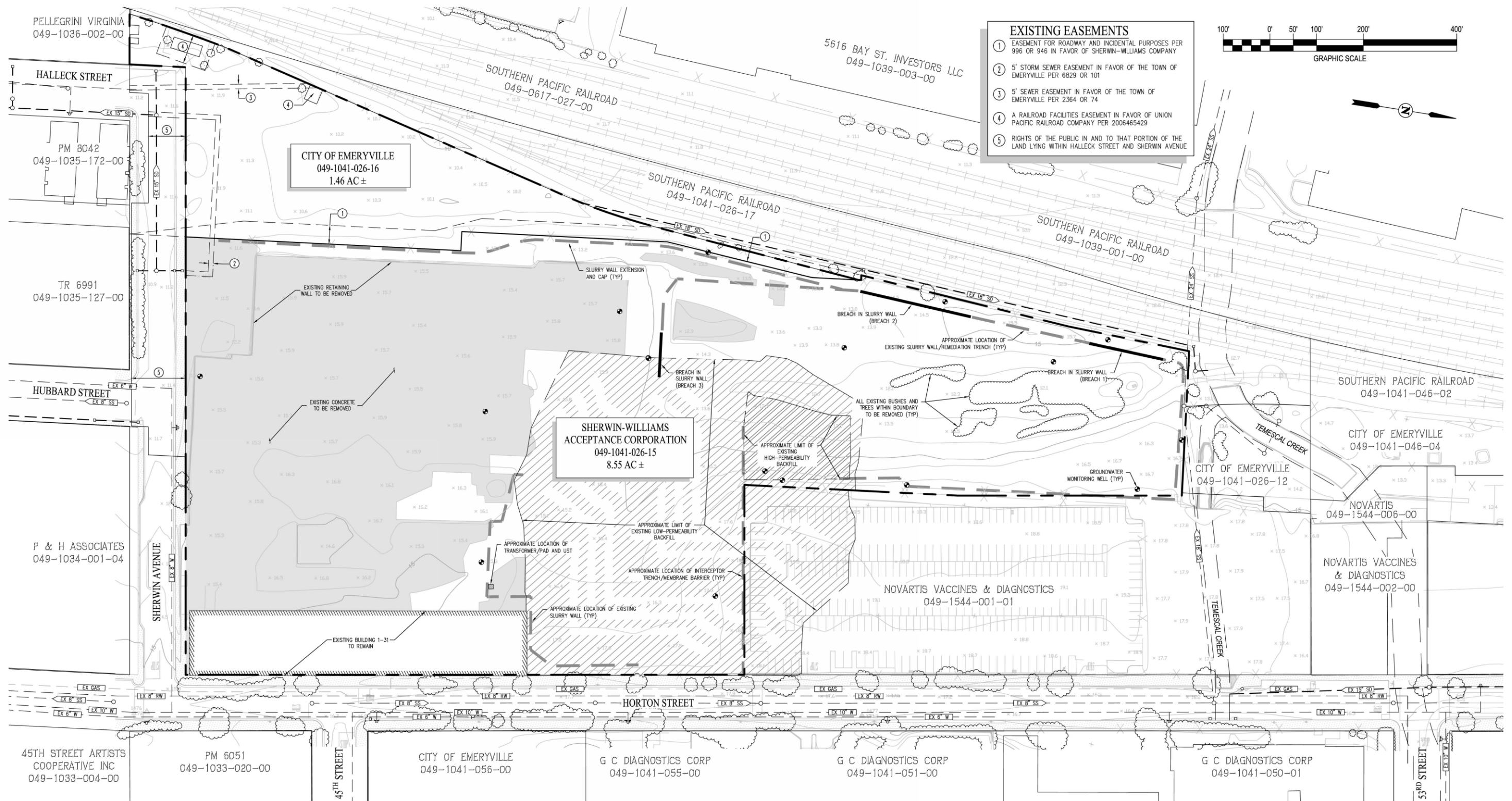

EXISTING CONDITIONS PLAN



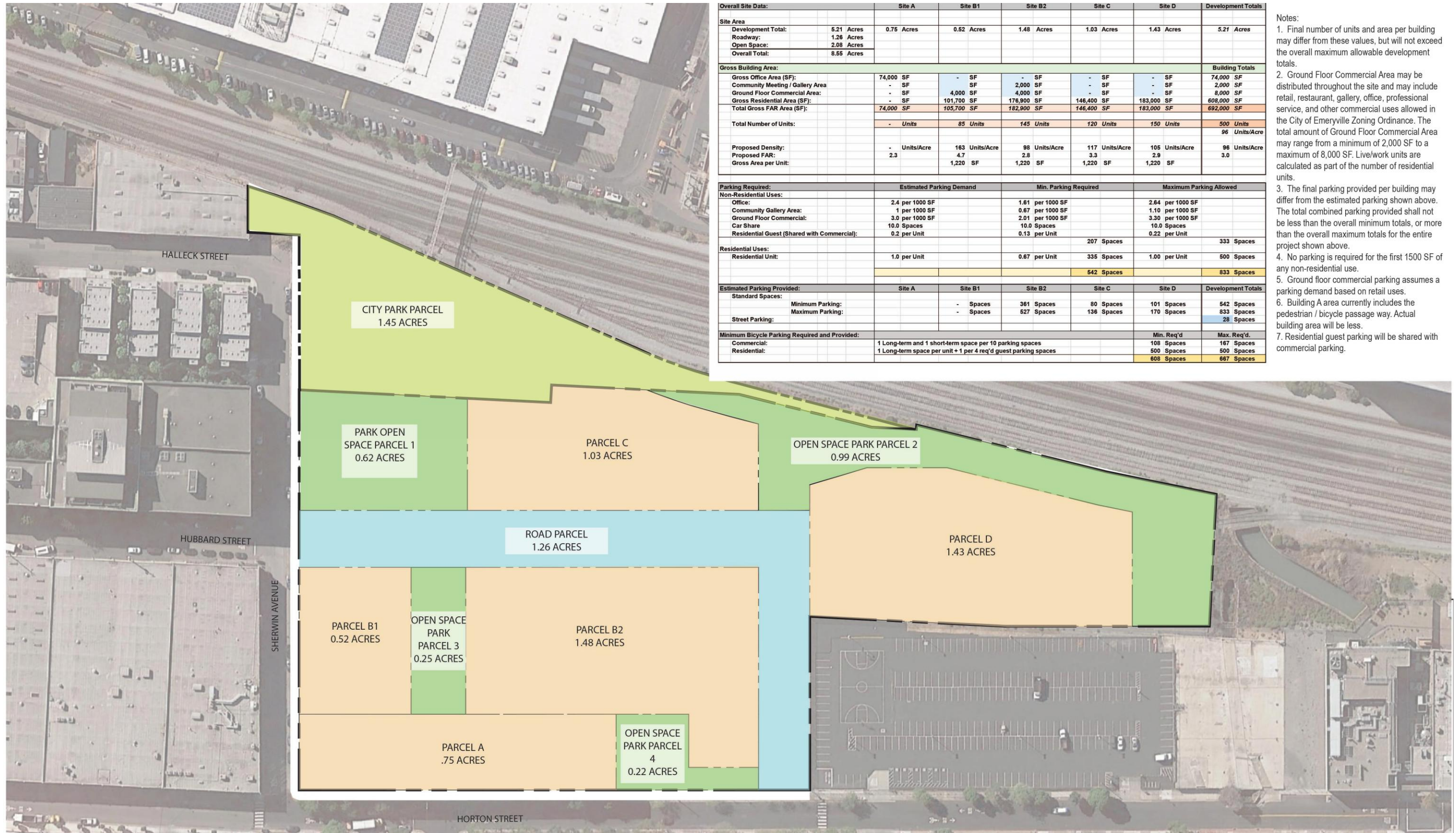

Overall Site Data:	Site A	Site B1	Site B2	Site C	Site D	Development Totals
Site Area						
Development Total:	5.21 Acres	0.75 Acres	0.52 Acres	1.48 Acres	1.03 Acres	5.21 Acres
Roadway:	1.26 Acres					
Open Space:	2.08 Acres					
Overall Total:	8.55 Acres					
<b>Gross Building Area:</b>						
Gross Office Area (SF):	74,000 SF	- SF	- SF	- SF	- SF	74,000 SF
Community Meeting / Gallery Area:	- SF	- SF	2,000 SF	- SF	- SF	2,000 SF
Ground Floor Commercial Area:	- SF	4,000 SF	4,000 SF	- SF	- SF	8,000 SF
Gross Residential Area (SF):	- SF	101,700 SF	176,900 SF	146,400 SF	183,000 SF	608,000 SF
Total Gross FAR Area (SF):	74,000 SF	105,700 SF	182,900 SF	146,400 SF	183,000 SF	692,000 SF
<b>Total Number of Units:</b>						
	- Units	85 Units	145 Units	120 Units	150 Units	500 Units
Proposed Density:	- Units/Acre	163 Units/Acre	98 Units/Acre	117 Units/Acre	105 Units/Acre	96 Units/Acre
Proposed FAR:	2.3	4.7	2.8	3.3	2.9	3.0
Gross Area per Unit:		1,220 SF	1,220 SF	1,220 SF	1,220 SF	
<b>Parking Required:</b>						
	Estimated Parking Demand		Min. Parking Required		Maximum Parking Allowed	
Non-Residential Uses:						
Office:	2.4 per 1000 SF		1.61 per 1000 SF		2.64 per 1000 SF	
Community Gallery Area:	1 per 1000 SF		0.67 per 1000 SF		1.10 per 1000 SF	
Ground Floor Commercial:	3.0 per 1000 SF		2.01 per 1000 SF		3.30 per 1000 SF	
Car Share:	10.0 Spaces		10.0 Spaces		10.0 Spaces	
Residential Guest (Shared with Commercial):	0.2 per Unit		0.13 per Unit		0.22 per Unit	
			207 Spaces		333 Spaces	
Residential Uses:						
Residential Unit:	1.0 per Unit		0.67 per Unit		1.00 per Unit	
			335 Spaces		500 Spaces	
			542 Spaces		833 Spaces	
<b>Estimated Parking Provided:</b>						
	Site A	Site B1	Site B2	Site C	Site D	Development Totals
Standard Spaces:						
Minimum Parking:		- Spaces	361 Spaces	80 Spaces	101 Spaces	542 Spaces
Maximum Parking:		- Spaces	527 Spaces	136 Spaces	170 Spaces	833 Spaces
Street Parking:						28 Spaces
<b>Minimum Bicycle Parking Required and Provided:</b>						
Commercial:	1 Long-term and 1 short-term space per 10 parking spaces				108 Spaces	167 Spaces
Residential:	1 Long-term space per unit + 1 per 4 req'd guest parking spaces				500 Spaces	500 Spaces
					608 Spaces	667 Spaces

- Notes:
- Final number of units and area per building may differ from these values, but will not exceed the overall maximum allowable development totals.
  - Ground Floor Commercial Area may be distributed throughout the site and may include retail, restaurant, gallery, office, professional service, and other commercial uses allowed in the City of Emeryville Zoning Ordinance. The total amount of Ground Floor Commercial Area may range from a minimum of 2,000 SF to a maximum of 8,000 SF. Live/work units are calculated as part of the number of residential units.
  - The final parking provided per building may differ from the estimated parking shown above. The total combined parking provided shall not be less than the overall minimum totals, or more than the overall maximum totals for the entire project shown above.
  - No parking is required for the first 1500 SF of any non-residential use.
  - Ground floor commercial parking assumes a parking demand based on retail uses.
  - Building A area currently includes the pedestrian / bicycle passage way. Actual building area will be less.
  - Residential guest parking will be shared with commercial parking.

LAND USE DIAGRAM

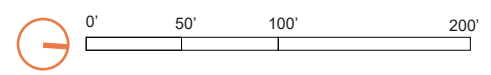





SITE DEVELOPMENT PLAN

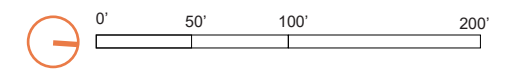





## ILLUSTRATIVE DEVELOPMENT CONCEPT





## GROUND FLOOR ACTIVATION

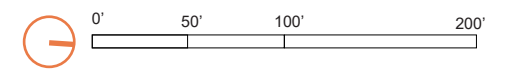



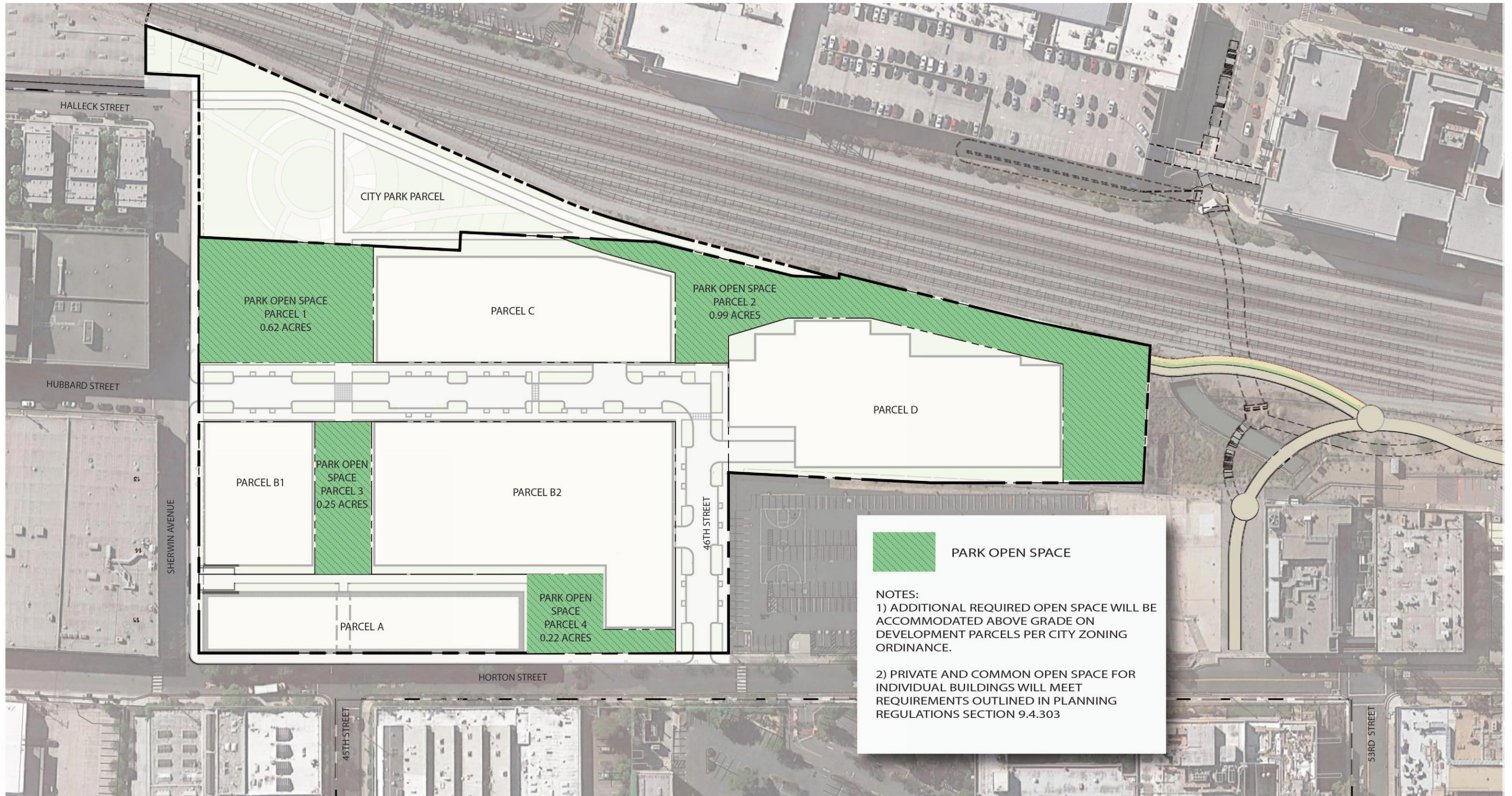

PUBLIC OPEN SPACE



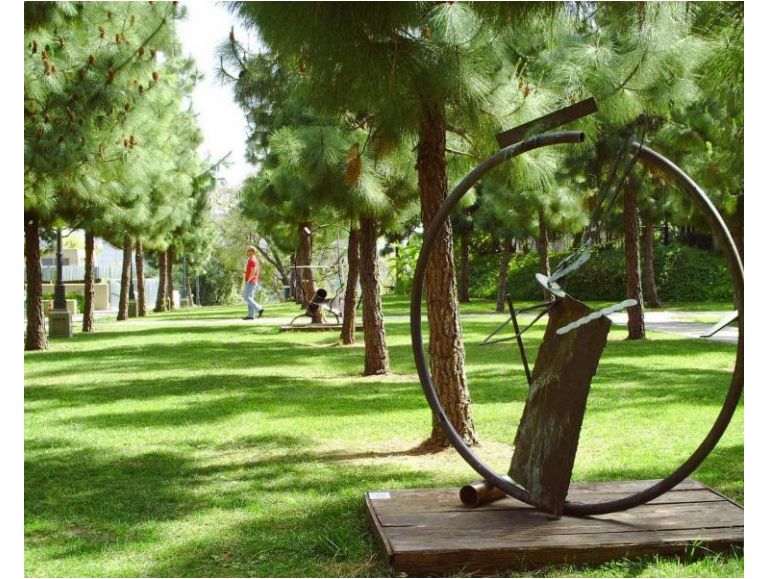

## OPEN SPACE PRECEDENTS

SHERWIN WILLIAMS PRELIMINARY DEVELOPMENT PLAN  
SEPTEMBER 13 2016, PREPARED FOR LMC EMERYVILLE I INVESTOR LLC BY LPAS AND CBG



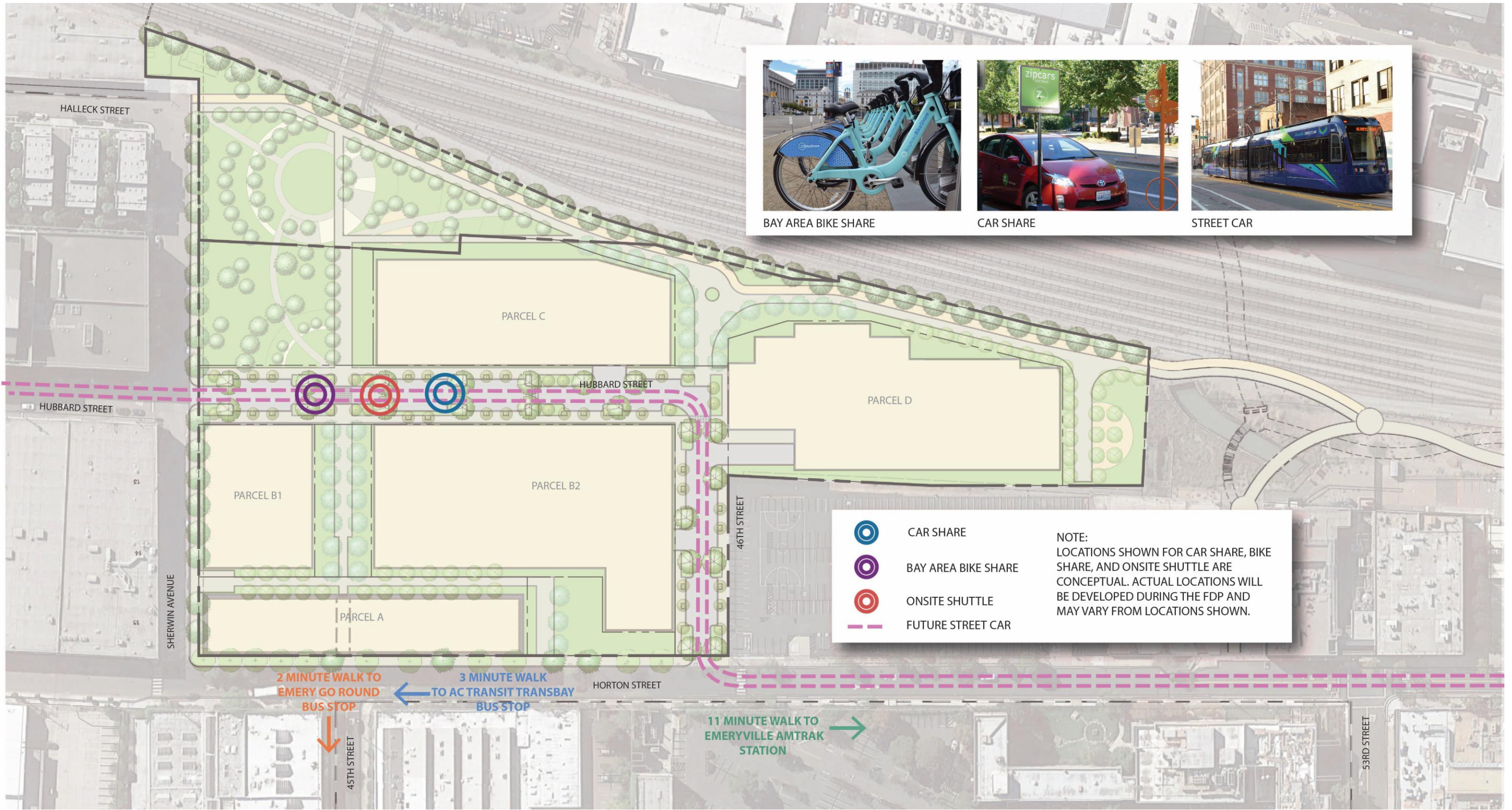

SITE TRANSPORTATION PLAN

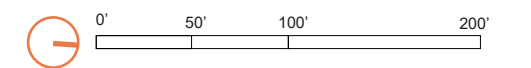





VEHICULAR CIRCULATION

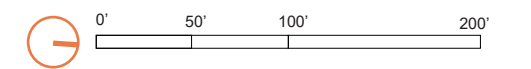





BICYCLE CIRCULATION





PEDESTRIAN CIRCULATION

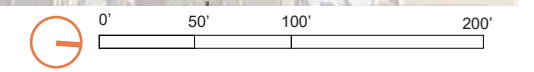





FIRE ACCESS PLAN

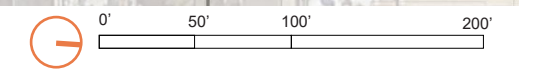





# LIGHTING PLAN





# LANDSCAPE PLAN

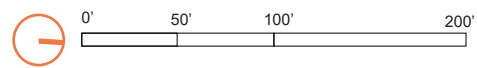





Arbutus 'Marina'  
(Strawberry Tree)



Elaeocarpus decipiens  
(Japanese Blueberry Tree)



Sophora japonica  
(Japanese Pagoda Tree)



Platanus x acerifolia  
London Plane Tree



Quercus shumardii  
(Shumard Oak)



Pinus eldarica  
(Afghan Pine)



Zelkova serrata  
(Japanese Zelkova)



Park Tree  
Acer rubrum  
(Red Maple)



Park Tree  
Ginkgo biloba  
(Ginkgo)



Park Tree  
Lagerstroemia indica  
(Crape Myrtle)



Park Tree  
Quercus suber  
(Cork Oak)



Park Tree  
Quercus virginiana  
(Southern Live Oak)

## LANDSCAPE PRECEDENTS





# STORMWATER TREATMENT CONCEPT



**STORMWATER CONTROL NOTES:**

1. ALL STORMWATER TREATMENT MEASURES AND TECHNICAL REQUIREMENTS FOR THIS PROJECT WILL BE BASED UPON THE ALAMEDA COUNTY CLEAN WATER PROGRAM.
2. ALL STORMWATER TREATMENT MEASURES AND LOCATIONS SHOWN ON THE STORMWATER TREATMENT CONCEPT PLAN ARE PRELIMINARY AND SUBJECT TO CHANGE PENDING FINAL DESIGN.

NOTE: FLOW-THROUGH PLANTERS SHALL BE VEGETATED CONSISTENT WITH ALAMEDA COUNTY C.3 GUIDELINES

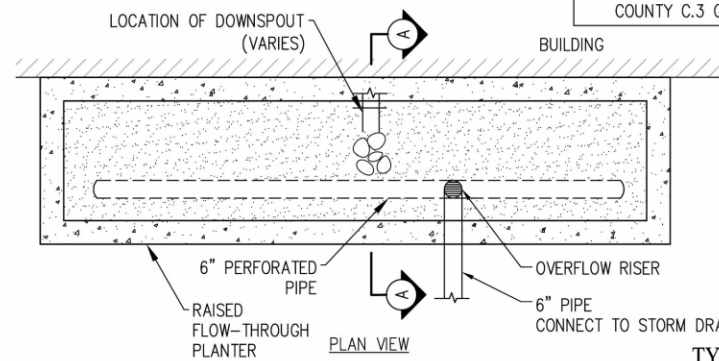

**TYPICAL RAISED FLOW-THROUGH PLANTER**  
NOT TO SCALE

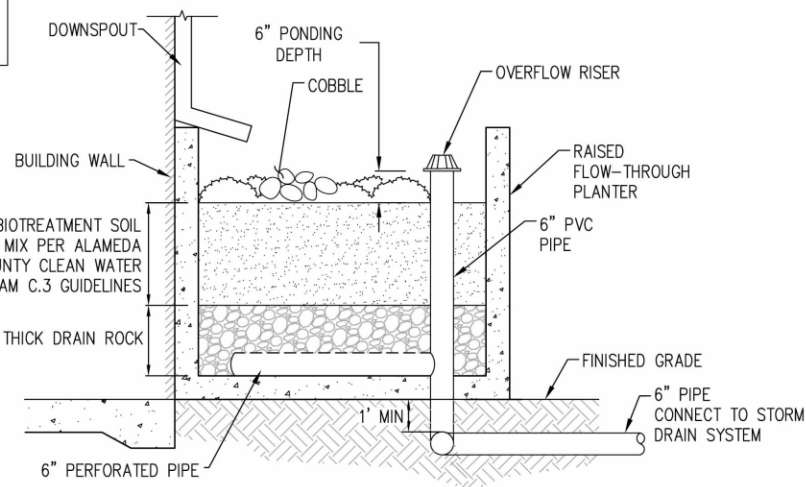

SECTION A-A



LANDSCAPE AREA MAY BE CONSIDERED SELF-TREATING IN CONFORMANCE WITH ALAMEDA COUNTY CLEAN WATER PROGRAM C.3 GUIDELINES.

**SELF-TREATING LANDSCAPE AREA**  
NOT TO SCALE

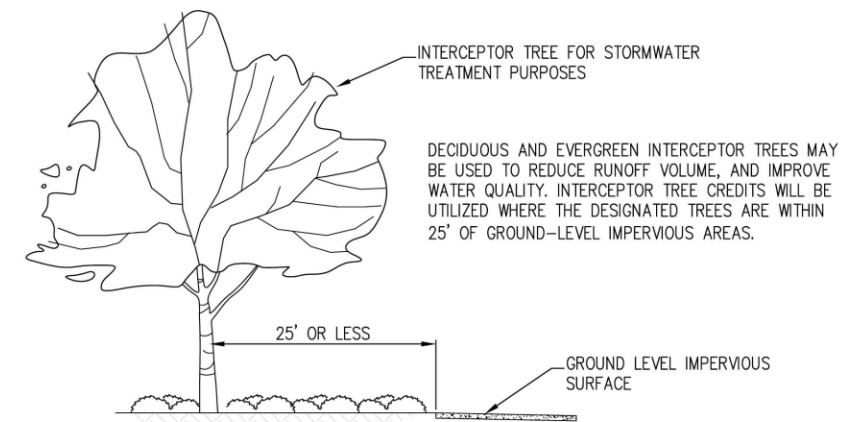

**TYPICAL STORMWATER INTERCEPTOR TREE**  
NOT TO SCALE

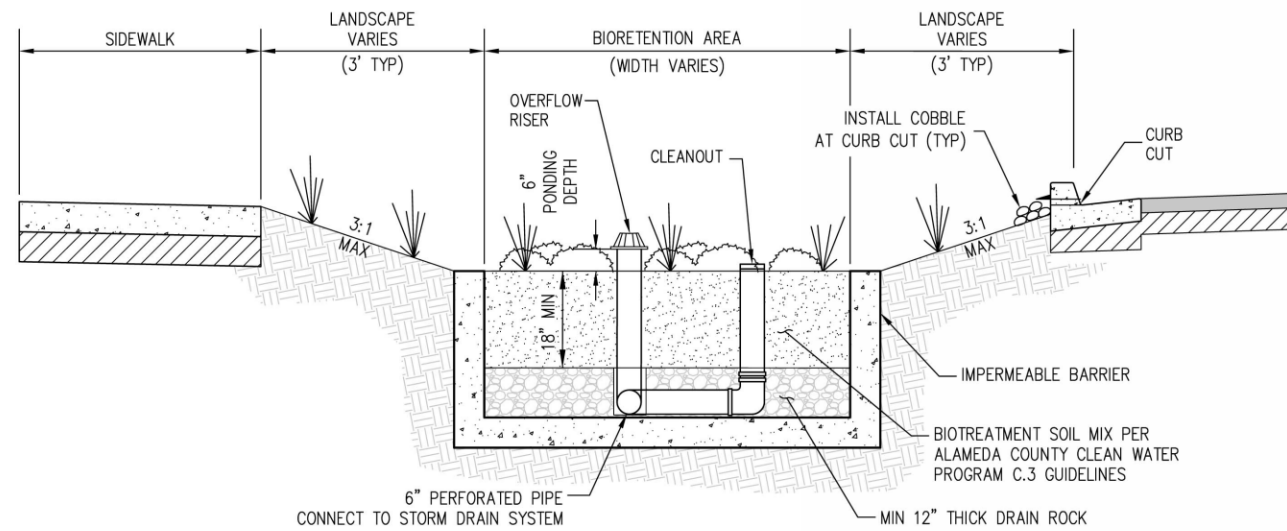

**TYPICAL AT-GRADE BIORETENTION AREA (WITHIN LANDSCAPE AREA)**  
NOT TO SCALE

NOTE: BIORETENTION AREAS SHALL BE VEGETATED CONSISTENT WITH ALAMEDA COUNTY C.3 GUIDELINES

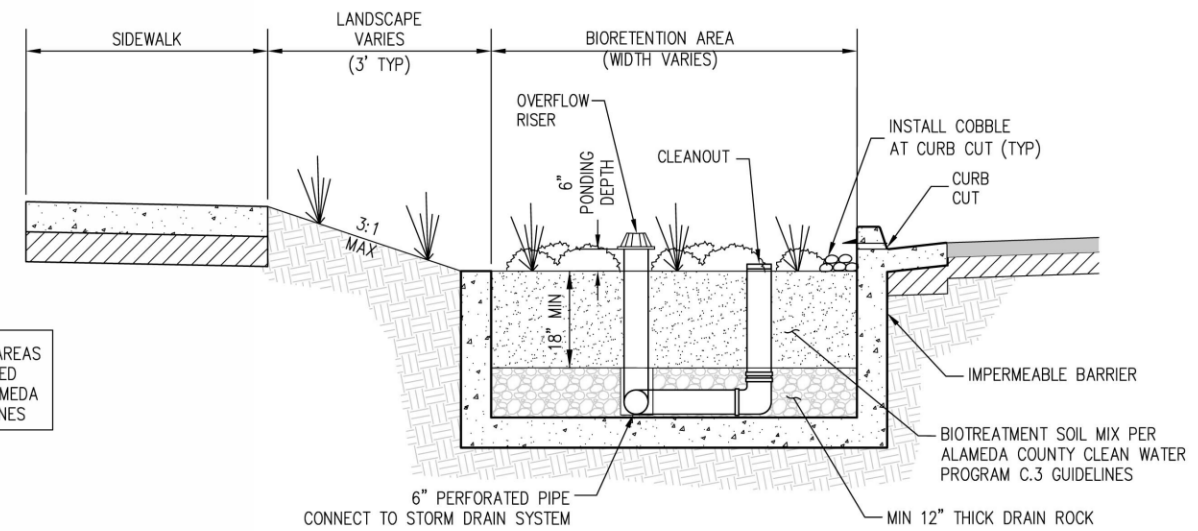

**TYPICAL AT-GRADE BIORETENTION AREA (ADJACENT TO ROADWAY)**  
NOT TO SCALE

**STORMWATER TREATMENT DETAILS**



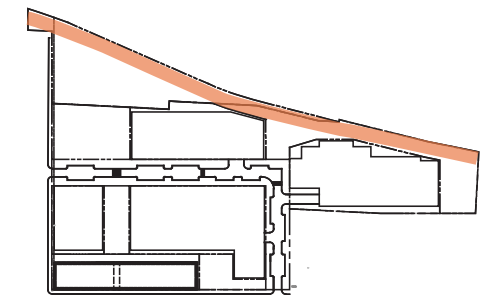
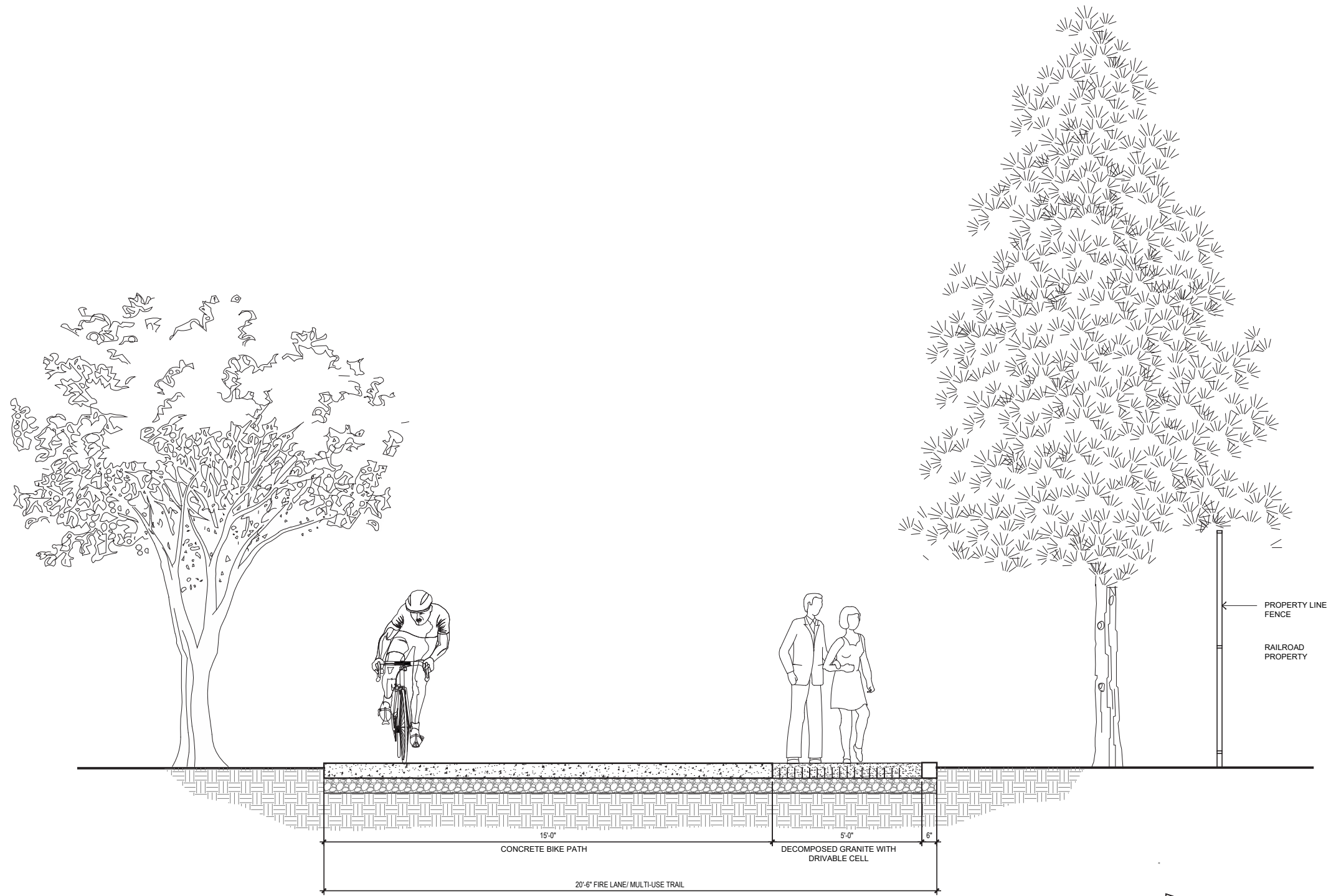

## FIRE LANE AND MULTI-USE TRAIL SECTION



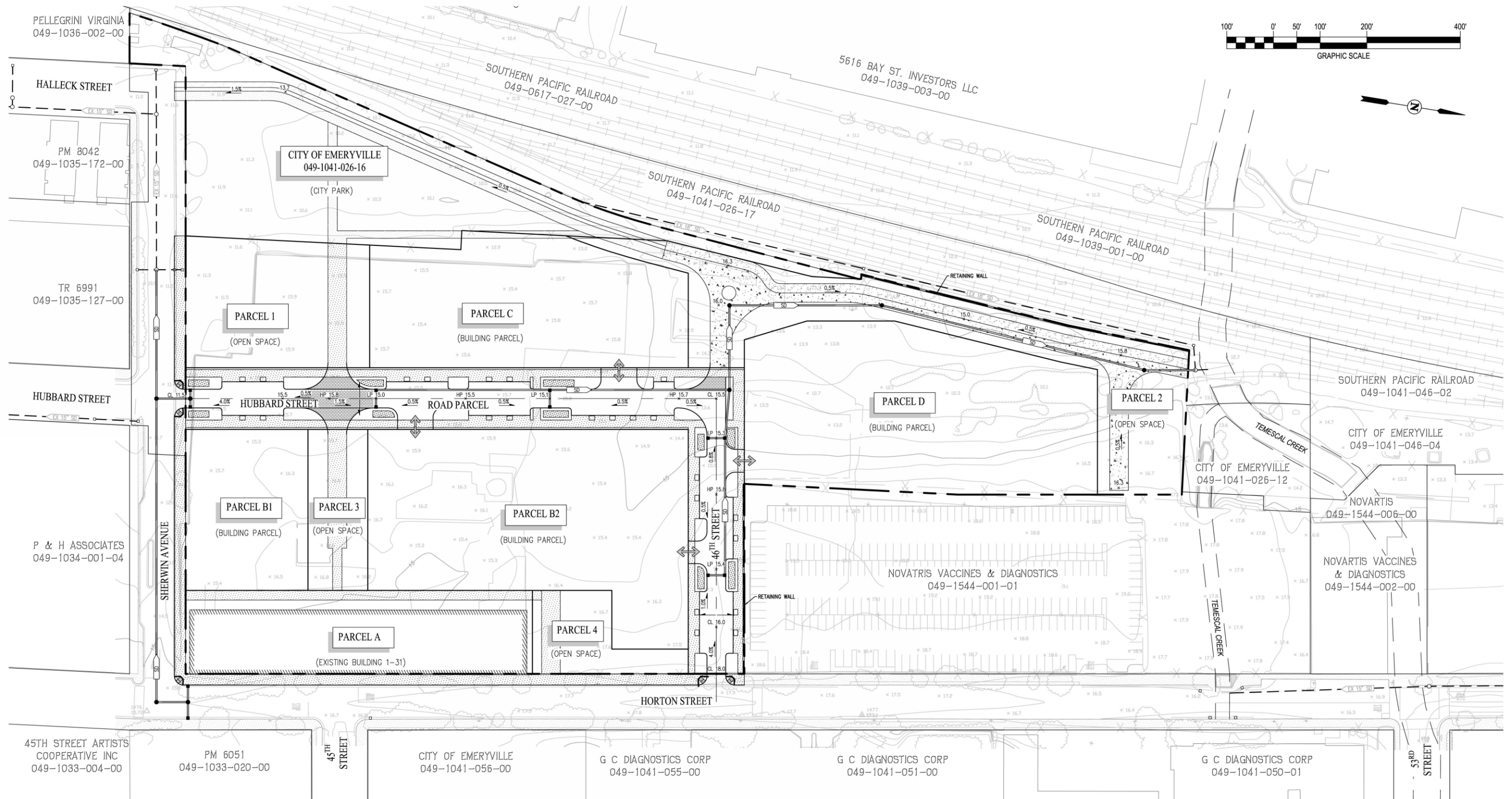

CONCEPTUAL GRADING PLAN



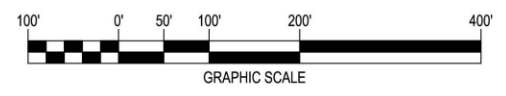
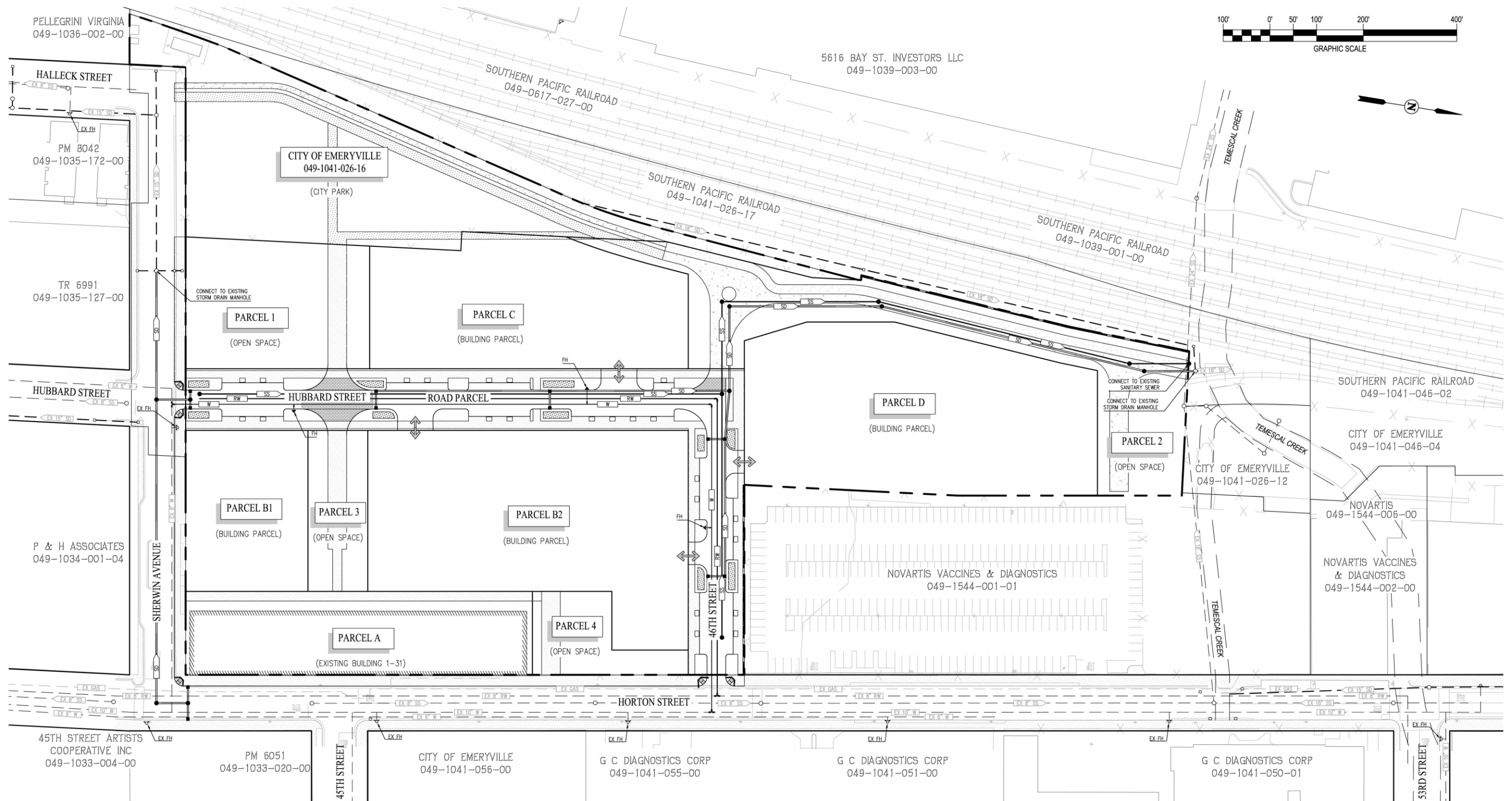

UTILITIES



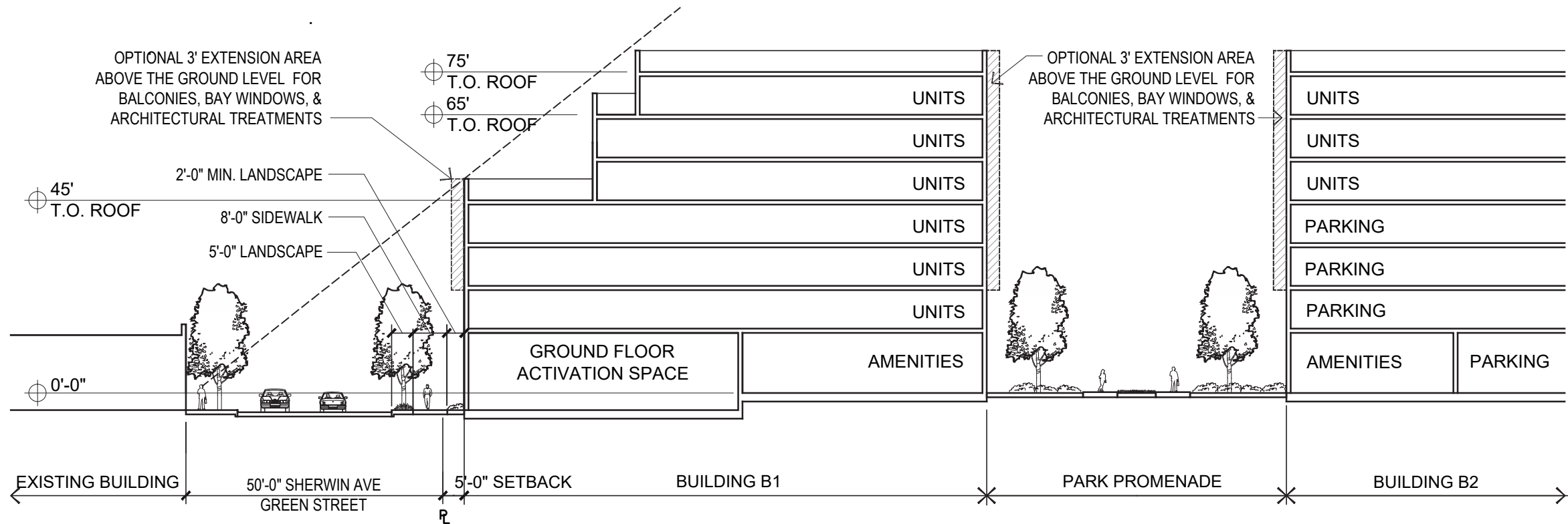

# SECTION A

SCALE 1" = 30'

NOTE: ADDITIONAL BUILDING STEP BACKS AND SETBACKS MAY BE DEVELOPED DURING THE FDP PROCESS

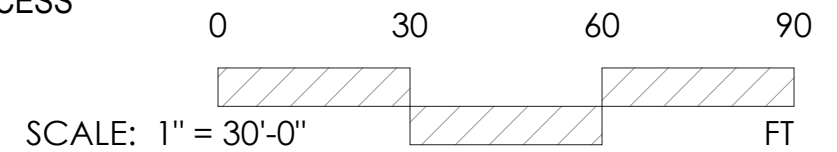

NOTES:

1. Ground floor activation spaces may have 1 or 2 floors
2. The existing retaining wall may be eliminated and the floor level may be lowered to ± 4.0 to activate sidewalk

## SITE SECTION A

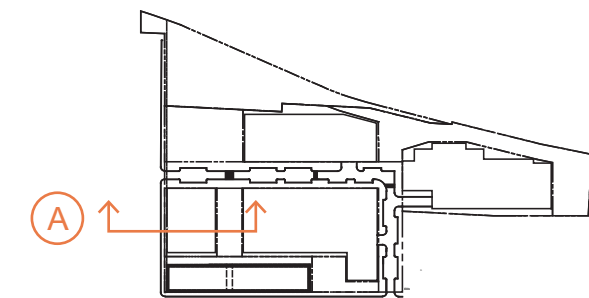

VICINITY MAP  
NOT TO SCALE



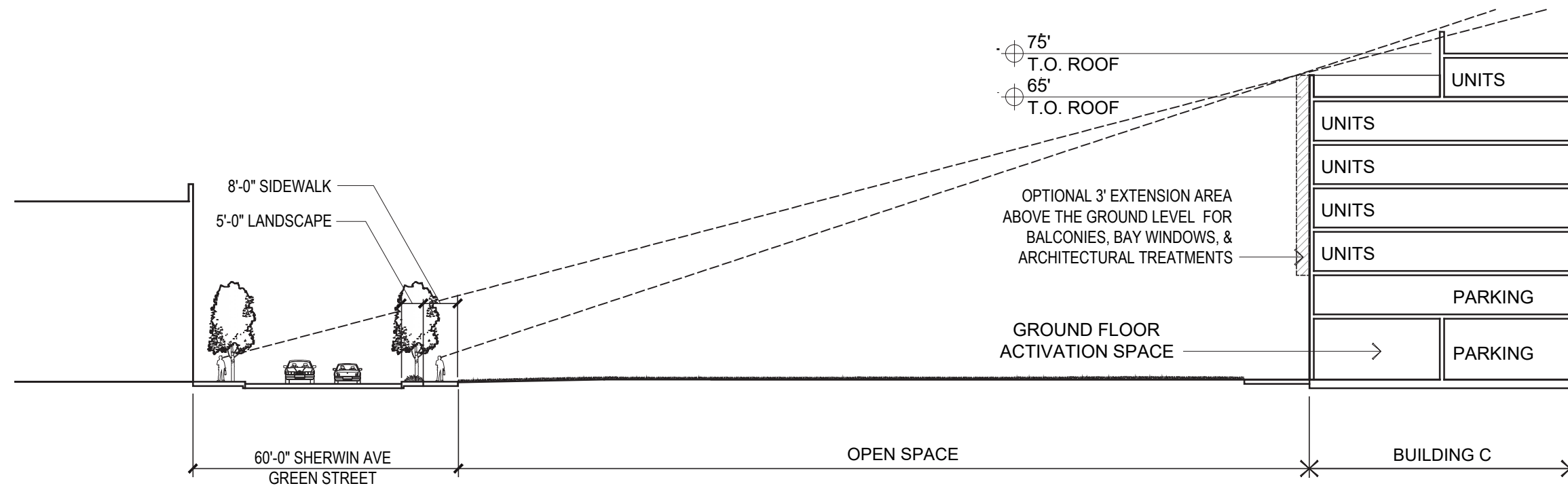

# SECTION B

SCALE 1" = 30'

NOTE: ADDITIONAL BUILDING STEP BACKS AND SETBACKS MAY BE DEVELOPED DURING THE FDP PROCESS

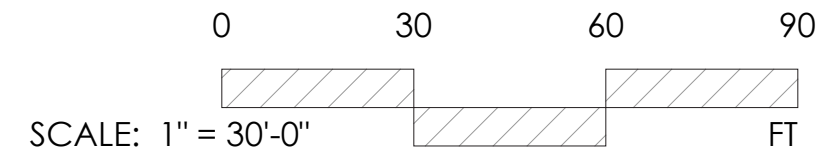

NOTES:

- 1. Ground floor activation spaces may have 1 or 2 floors

## SITE SECTION B

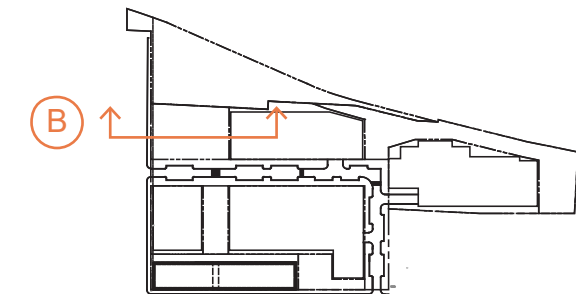

VICINITY MAP  
NOT TO SCALE



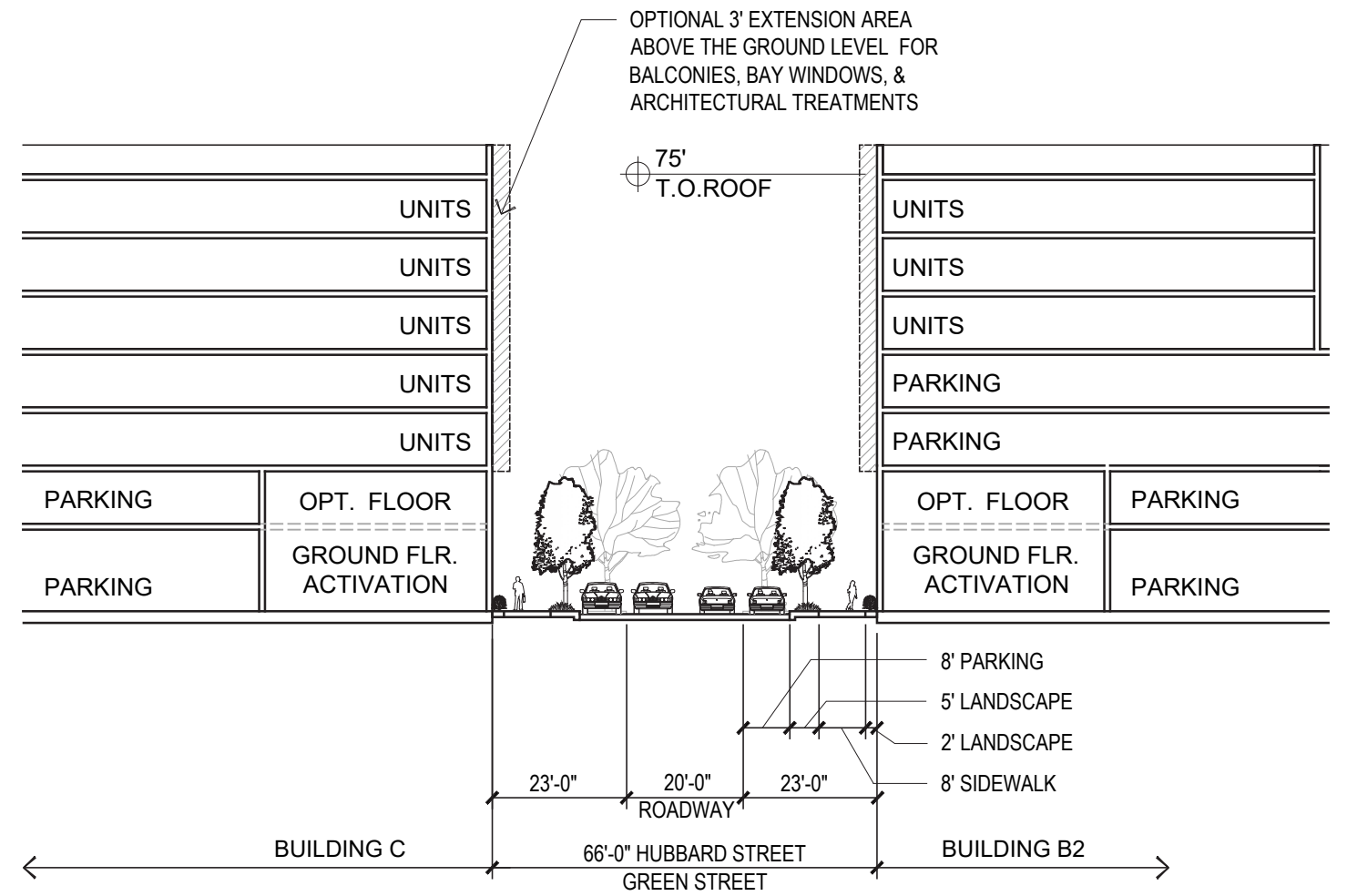
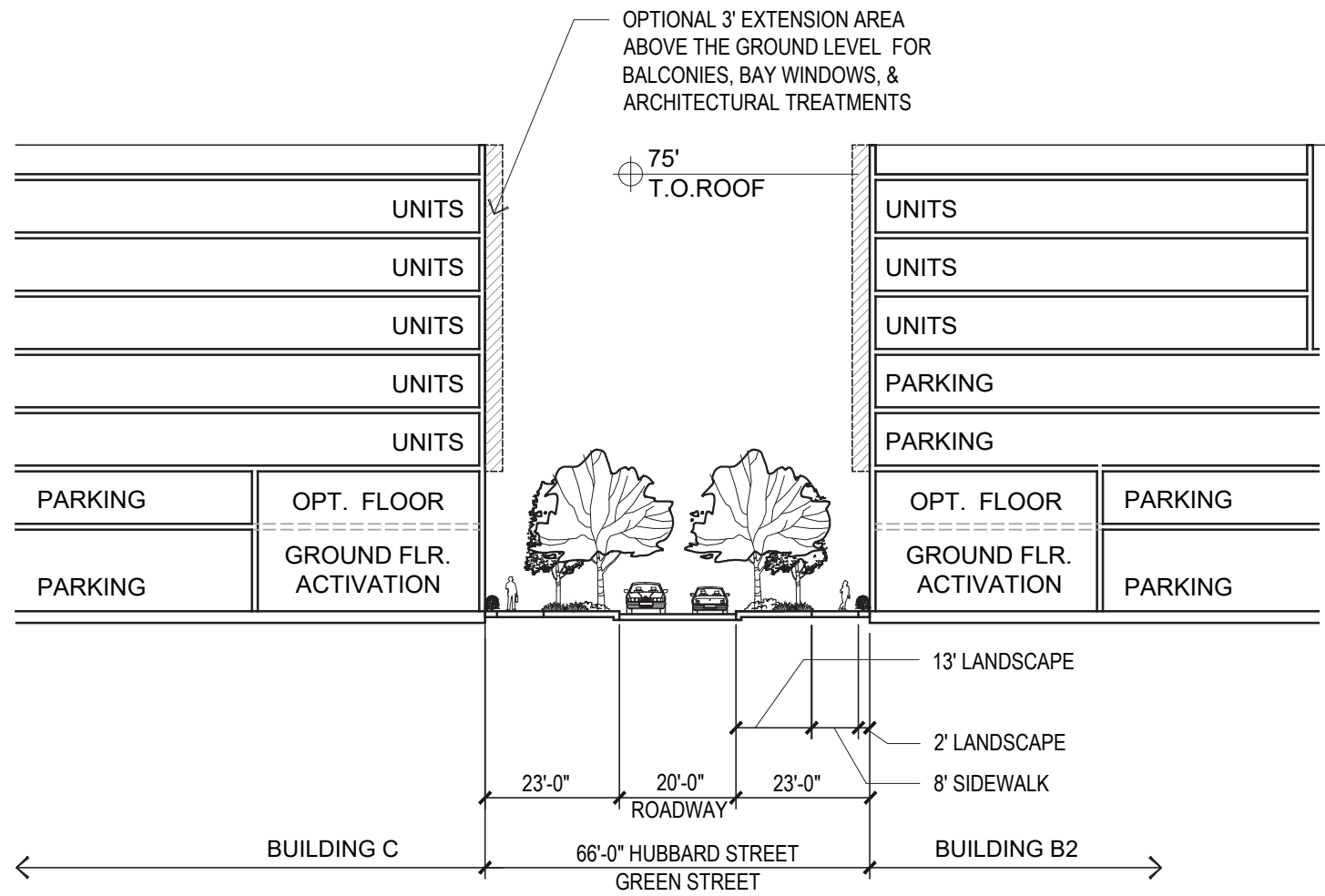

## SECTION C WITHOUT PARKING

## SECTION C WITH PARKING

SCALE 1" = 30'

NOTE: ADDITIONAL BUILDING STEP BACKS AND SETBACKS MAY BE DEVELOPED DURING THE FDP PROCESS

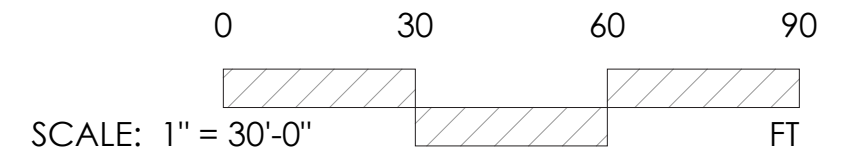

NOTES:

1. Ground floor activation spaces may have 1 or 2 floors

## SITE SECTION C

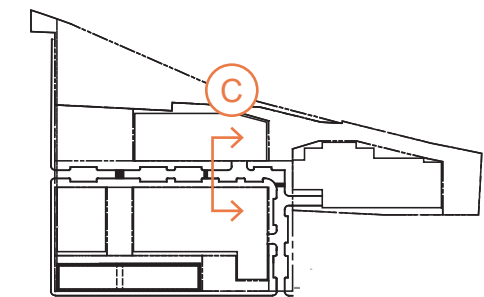

VICINITY MAP  
NOT TO SCALE



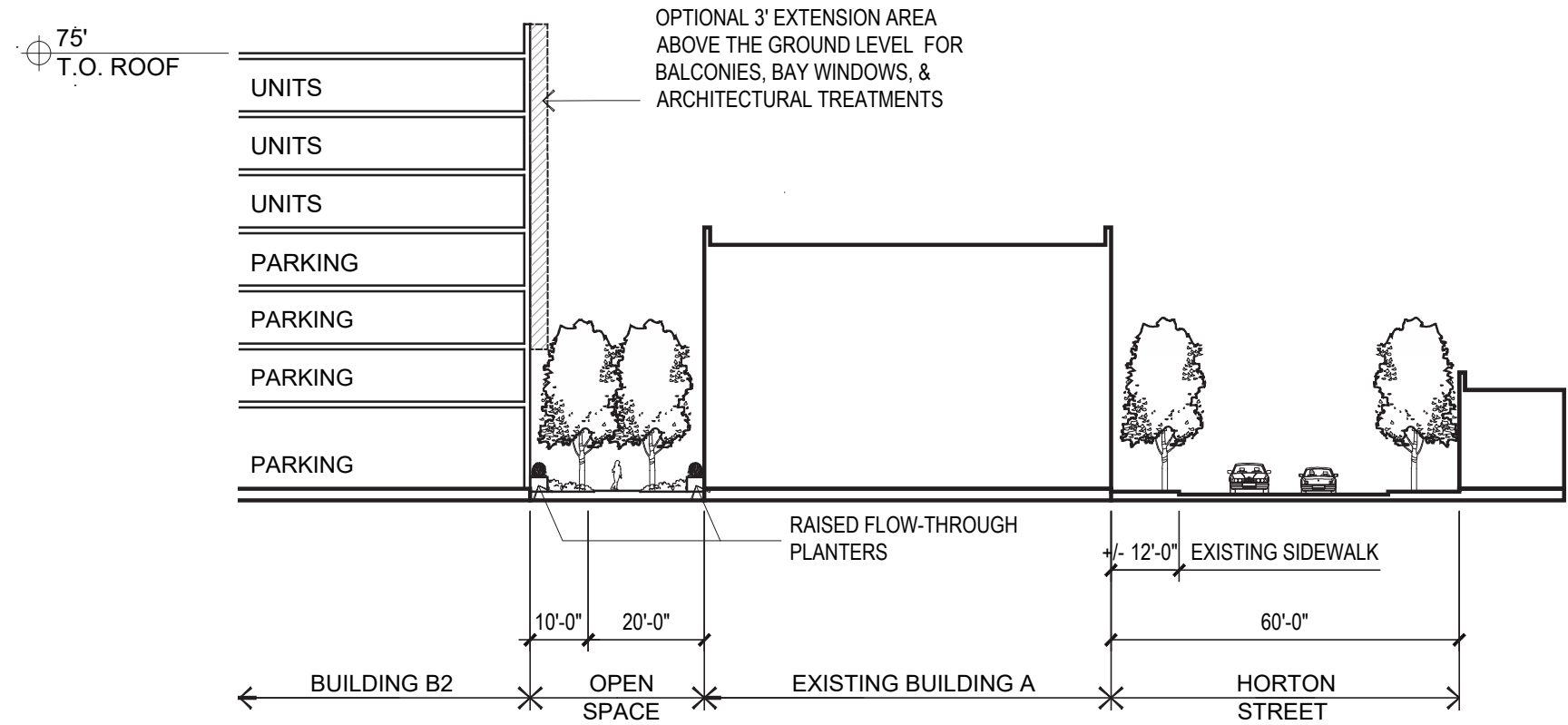

# SECTION D

SCALE 1" = 30'

NOTE: ADDITIONAL BUILDING STEP BACKS AND SETBACKS MAY BE DEVELOPED DURING THE FDP PROCESS

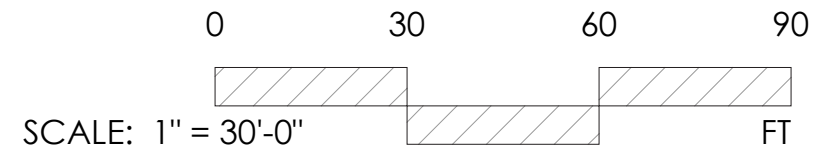

NOTES:

- 1. Ground floor activation spaces may have 1 or 2 floors

## SITE SECTION D

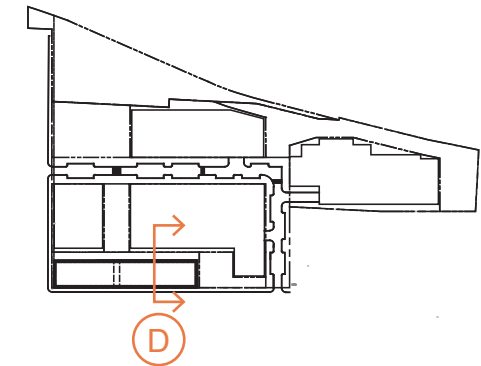

VICINITY MAP  
NOT TO SCALE



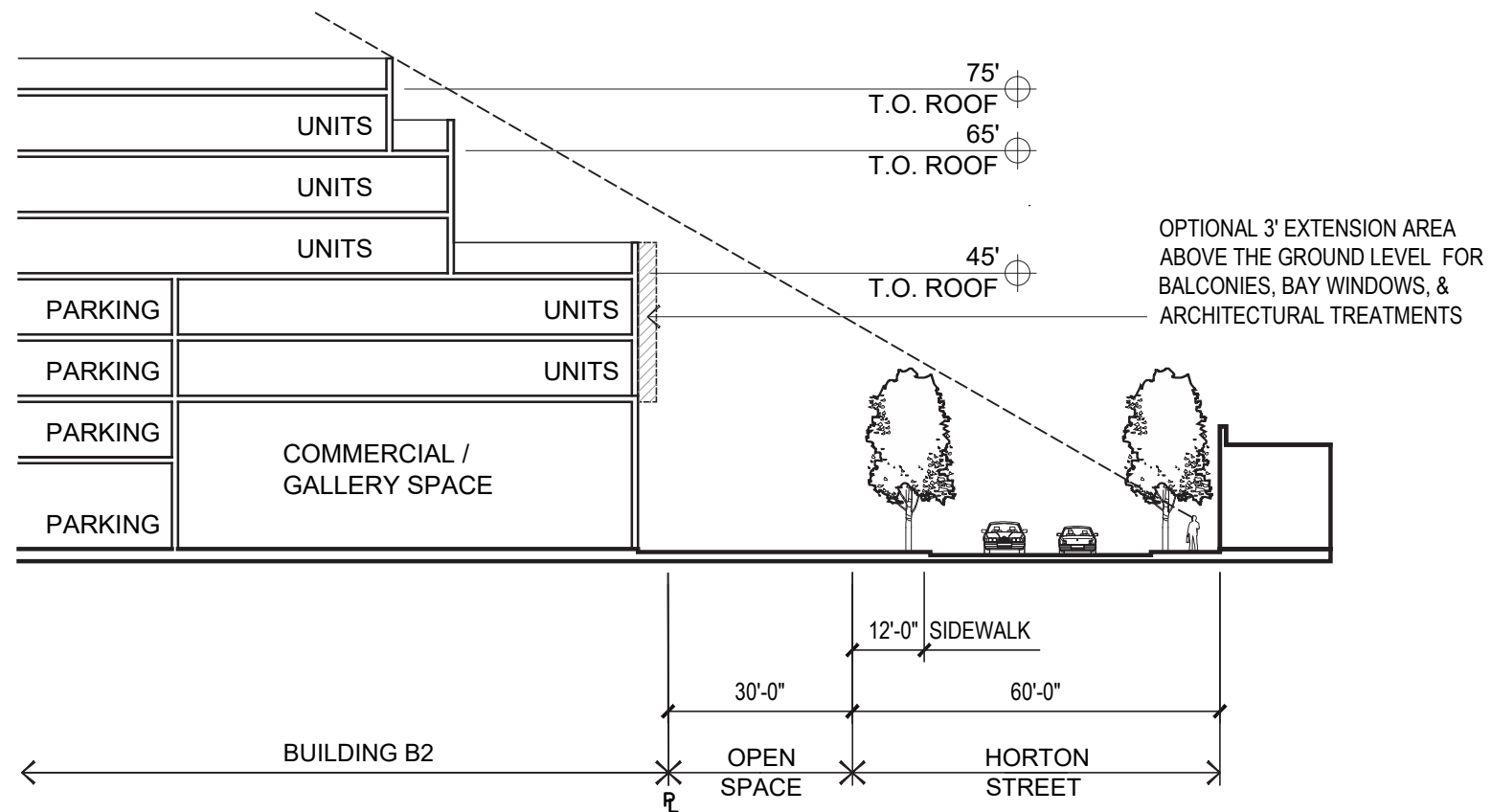

# SECTION E

SCALE 1" = 30'

NOTE: ADDITIONAL BUILDING STEP BACKS AND SETBACKS MAY BE DEVELOPED DURING THE FDP PROCESS

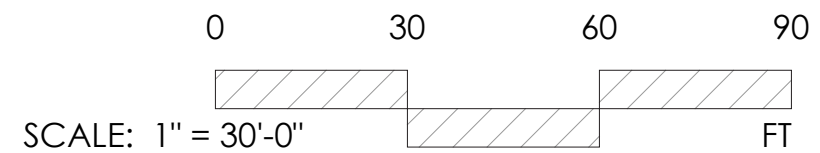

NOTES:

- 1. Ground floor activation spaces may have 1 or 2 floors

## SITE SECTION E

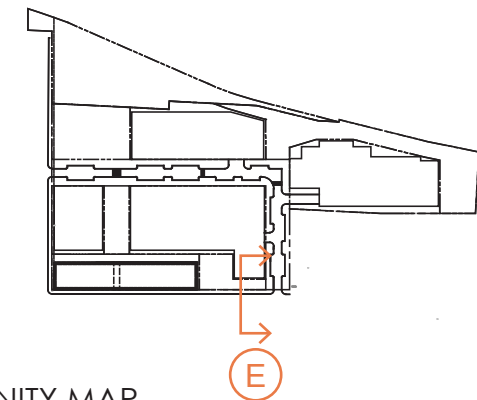

VICINITY MAP  
 NOT TO SCALE



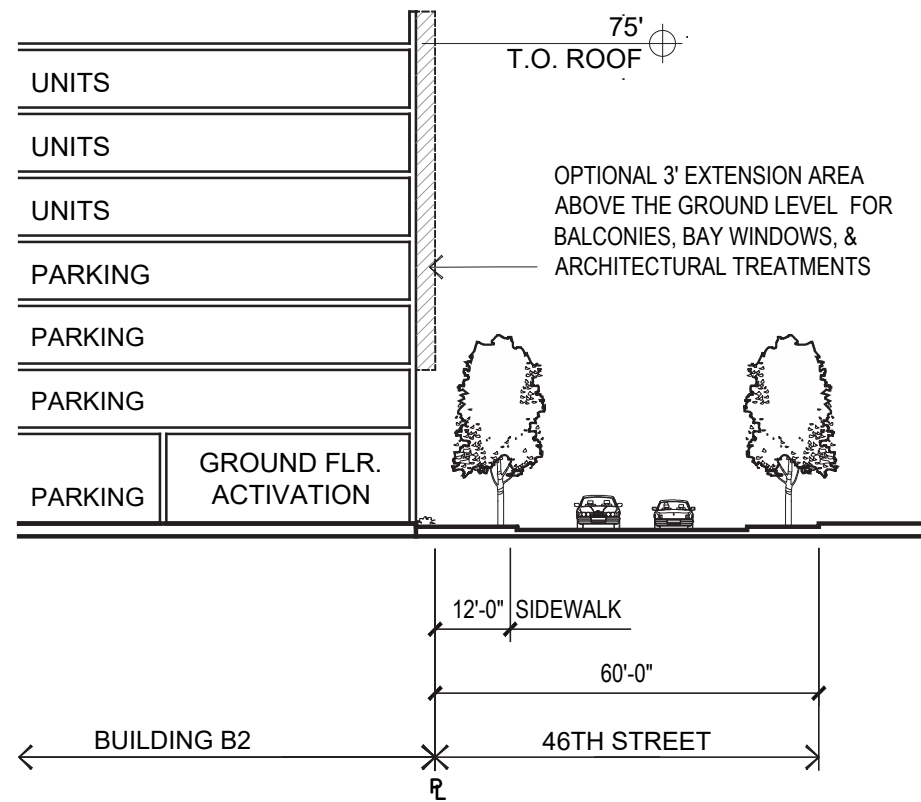

# SECTION F

SCALE 1" = 30'

NOTE: ADDITIONAL BUILDING STEP BACKS AND SETBACKS MAY BE DEVELOPED DURING THE FDP PROCESS

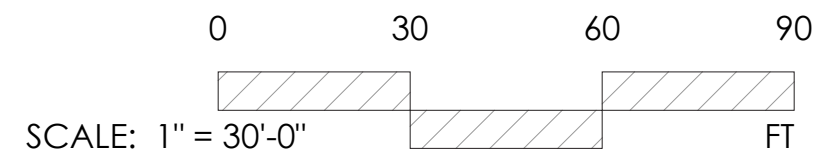

NOTES:

- 1. Ground floor activation spaces may have 1 or 2 floors

## SITE SECTION F

